

Heldu rectangular table

760 x 750 x 850 mm

Design by Jean Louis Iratzoki



The Heldu table has a solid oak construction. Solid oak or laminated top. It is available in four different sizes. Three of these can be extensibles.

CATEGORY:

Table

ENVIRONMENT:

Indoor

APPLICATIONS:

- CHR
- Public
- Office

WEIGHT: 19 kg

MATERIALS:

Solid oak construction. Solid oak top (3 ply, 22 mm thickness) or laminate top.

MADE TO ORDER: Finishes and upholsteries, page 2

ACCESSORIES: No

ASSEMBLED PRODUCT: Yes

REMOVABLE PRODUCT: No

CLEANING AND CARE INSTRUCTIONS:

Dry cloth. To avoid aerosol and spray products with silicone.

DOWNLOADS:

3D and 2D files are available at alki.fr – images bank section.

HELDU COLLECTION:



DIMENSIONS :

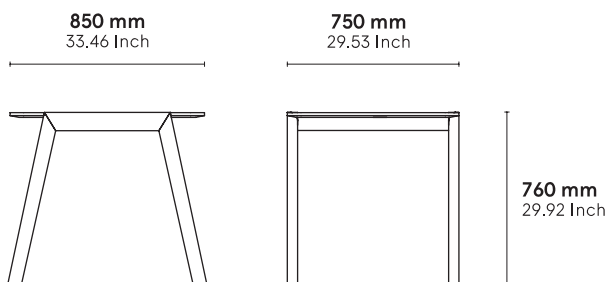

Non contractual document - modifiable without previous notice.

Heldu rectangular table

760 x 1300 x 850 mm

Design by Jean Louis Iratzoki



The Heldu table has a solid oak construction. Solid oak or laminated top. It is available in four different sizes. Three of these can be extensibles.

CATEGORY:

Table

ENVIRONMENT:

Indoor

APPLICATIONS:

- CHR
- Public
- Office

WEIGHT: 30 kg

MATERIALS:

Solid oak construction. Solid oak top (3 ply, 22 mm thickness) or laminate top.

MADE TO ORDER: Finishes and upholsteries, page 2

ACCESSORIES: No

ASSEMBLED PRODUCT: Yes

REMOVABLE PRODUCT: No

CLEANING AND CARE INSTRUCTIONS:

Dry cloth. To avoid aerosol and spray products with silicone.

DOWNLOADS:

3D and 2D files are available at alki.fr – images bank section.

HELDU COLLECTION:



DIMENSIONS :

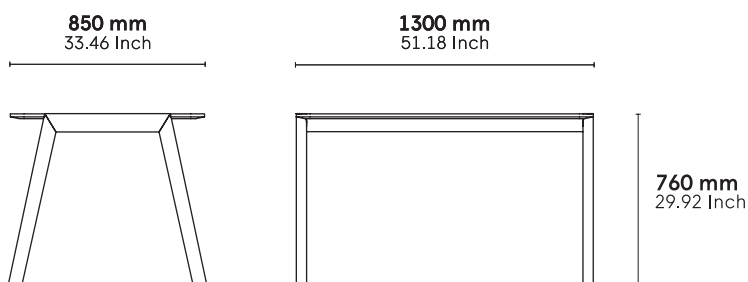

Non contractual document - modifiable without previous notice.

Heldu rectangular table

760 x 1300/1850 x 850 mm

Design by Jean Louis Iratzoki



The Heldu table has a solid oak construction. Solid oak or laminated top. It is available in four different sizes. Three of these can be extensibles.

CATEGORY:

Table

ENVIRONMENT:

Indoor

APPLICATIONS:

- CHR
- Public
- Office

WEIGHT: 45 kg

MATERIALS:

Solid oak construction. Solid oak top (3 ply, 22 mm thickness) or laminate top. 550 mm foldable extension, in solid oak or laminate top.

MADE TO ORDER: Finishes and upholsteries, page 2

ACCESSORIES: No

ASSEMBLED PRODUCT: Yes

REMOVABLE PRODUCT: No

CLEANING AND CARE INSTRUCTIONS:

Dry cloth. To avoid aerosol and spray products with silicone.

DOWNLOADS:

3D and 2D files are available at alki.fr – images bank section.

HELDU COLLECTION:



DIMENSIONS :

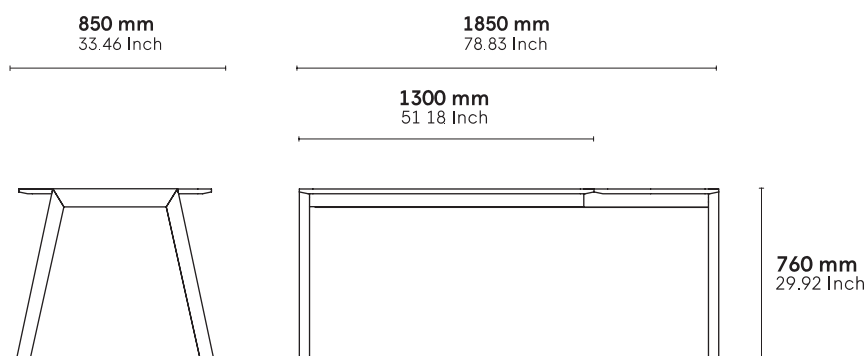

Non contractual document - modifiable without previous notice.

Heldu rectangular table

760 x 1900 x 950 mm

Design by Iratzoki Lizaso



The Heldu table has a solid oak construction. Solid oak or laminated top. It is available in four different sizes. Three of these can be expandable.

CATEGORY:

Table

ENVIRONMENT:

Indoor

APPLICATIONS:

- CHR
- Public
- Office

WEIGHT: 38,5 kg

MATERIALS:

Solid oak construction. Solid oak top (3 ply, 22 mm thickness) or laminate top.

MADE TO ORDER: Finishes page 2

ACCESSORIES: No

ASSEMBLED PRODUCT: Yes

REMOVABLE PRODUCT: No

CLEANING AND CARE INSTRUCTIONS:

Dry cloth. To avoid aerosol and spray products with silicone.

DOWNLOADS:

3D and 2D files are available at alki.fr – images bank section.

HELDU COLLECTION:



DIMENSIONS :

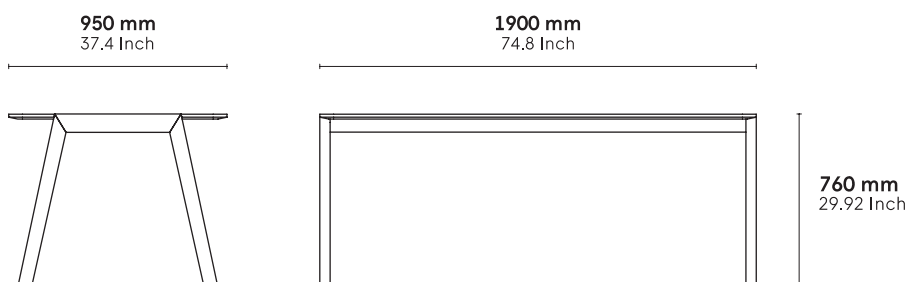

Non contractual document - modifiable without previous notice.

Heldu rectangular table

760 x 1900/2450 x 950 mm

Design by Jean Louis Iratzoki



The Heldu table has a solid oak construction. Solid oak or laminated top. It is available in four different sizes. Three of these can be extensibles.

CATEGORY:

Table

ENVIRONMENT:

Indoor

APPLICATIONS:

- CHR
- Public
- Office

WEIGHT: 53,5 kg

MATERIALS:

Solid oak construction. Solid oak top (3 ply, 22 mm thickness) or laminate top. 550 mm foldable extension, in solid oak or laminate top.

MADE TO ORDER: Finishes and upholsteries, page 2

ACCESSORIES: No

ASSEMBLED PRODUCT: Yes

REMOVABLE PRODUCT: No

CLEANING AND CARE INSTRUCTIONS:

Dry cloth. To avoid aerosol and spray products with silicone.

DOWNLOADS:

3D and 2D files are available at alki.fr – images bank section.

HELDU COLLECTION:



DIMENSIONS :

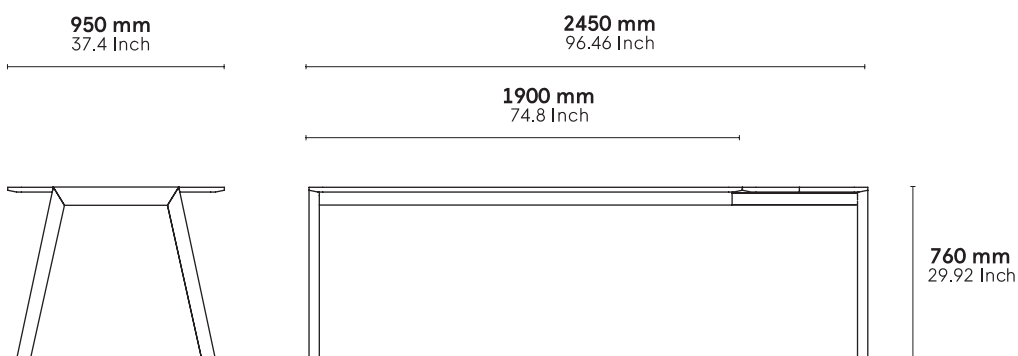

Non contractual document - modifiable without previous notice.

Heldu rectangular table

760 x 2450 x 950 mm

Design by Jean Louis Iratzoki



The Heldu table has a solid oak construction. Solid oak or laminated top. It is available in four different sizes. Three of these can be extensibles.

CATEGORY:

Table

ENVIRONMENT:

Indoor

APPLICATIONS:

- CHR
- Public
- Office

WEIGHT: 48,5 kg

MATERIALS:

Solid oak construction. Solid oak top (3 ply, 22 mm thickness) or laminate top.

MADE TO ORDER: Finishes and upholsteries, page 2

ACCESSORIES: No

ASSEMBLED PRODUCT: Yes

REMOVABLE PRODUCT: No

CLEANING AND CARE INSTRUCTIONS:

Dry cloth. To avoid aerosol and spray products with silicone.

DOWNLOADS:

3D and 2D files are available at alki.fr – images bank section.

HELDU COLLECTION:



DIMENSIONS :

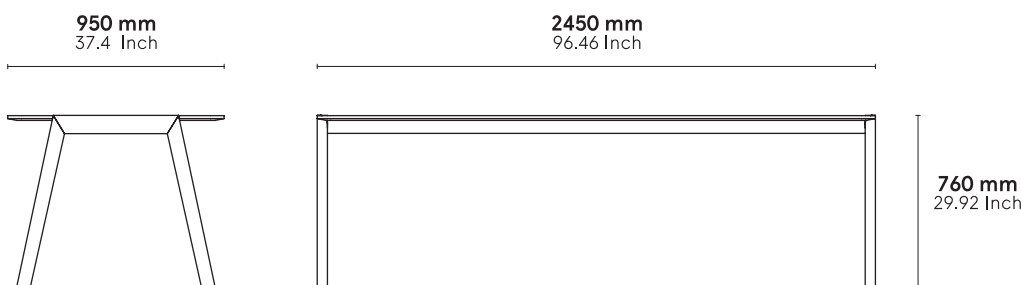

Non contractual document - modifiable without previous notice.

Finishes

Wood



Natural Oak

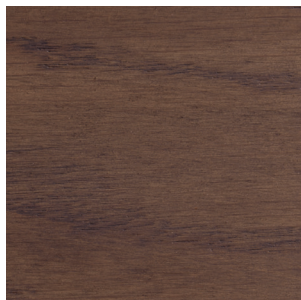

Ash Grey Oak

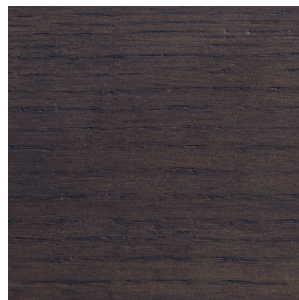

Tourbe Oak



Carbon Oak



Walnut Stained Oak



White Stained Oak

Fenix Technical Surface

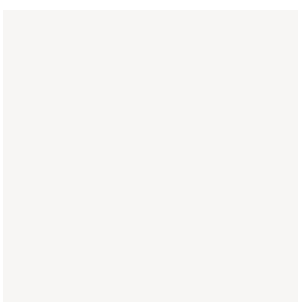

White 0032



Black 0720